

# TISSEL-200

## Electrobombas con variador de velocidad

 Agua limpia

 Uso agrícola

 Uso civil



TS2-MK



TS2-FCR



TS2-PLURIJET

### DESCRIPCIÓN

- Los **TISELL 200** son unidades de bombeo compactas, constituidas por una electrobomba centrífuga y por un regulador de velocidad (inverter) completo de sensores de presión externo que se debe instalar en un punto de la instalación.
- Robusto y sencillo de utilizar, TISSEL 100 es ideal para mantener siempre constante la presión de la instalación incluso cuando cambia el número de usos.
- Regulador de velocidad integrado con ventilación forzada y con grado de protección IP 54. Alimentado por una tensión alterna monofase ( $230 \pm 10\% V - 50/60 \text{ Hz}$ ), suministra una tensión de salida alterna trifase que alimenta el motor de la electrobomba con clase de rendimiento IE3.
- Arranques y paradas progresivas de la bomba.
- Menor desgaste de la electrobomba gracias a la modulación de la velocidad de funcionamiento por parte del inverter.

### PROTECCIÓN

- **Marcha en seco**  
La lógica del microprocesor detiene la bomba después de pocos segundos y realiza arranques programados en el tiempo para verificar el retorno del agua.
- **Marcha con presión inferior a la mínima programada**  
Detiene la bomba después de pocos segundos (por ejemplo cuando se produce la ruptura de una tubería).
- **Corrientes – tensiones – temperaturas**  
Limita las corrientes; avisa si la tensión sobrepasa los límites consentidos; protege de sobre temperaturas y de cortocircuitos entre las fases en salida.

### EJECUCIÓN Y NORMAS DE SEGURIDAD

EN 60335-1  
IEC 60335-1  
CEI 61-150

EN 60034-1  
IEC 60034-1  
CEI 2-3



### AHORRO DE ENERGÍA

Trabajando a velocidad variable, TISSEL-100 consume solamente la energía demandada por la instalación, en relación con la demanda idrúca.

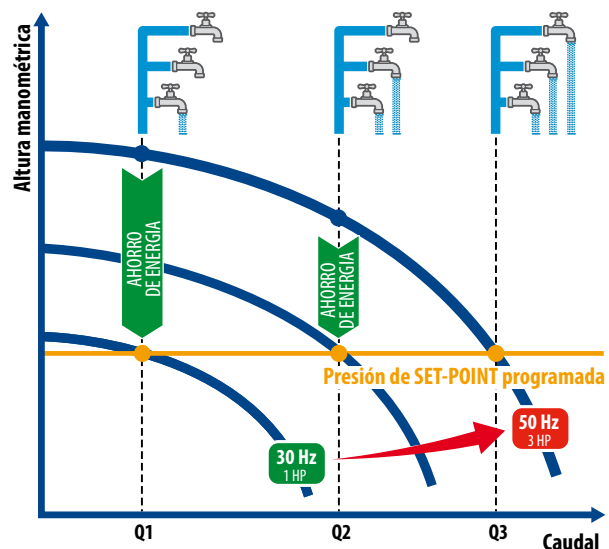

### CERTIFICACIONES

Empresa con sistema de gestión certificado DNV  
ISO 9001: CALIDAD

### GARANTIA

2 años según nuestras condiciones generales de venta.

CAMPO DE PRESTACIONES n= 3450 min<sup>-1</sup>

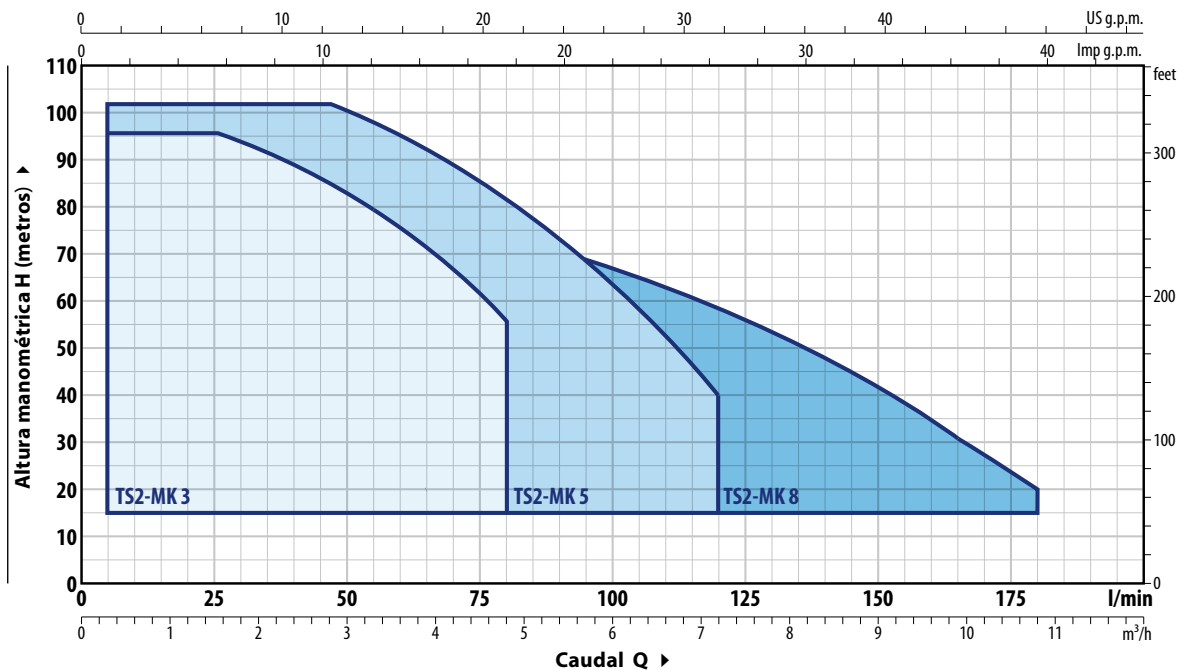

MODELO	POTENCIA		AMPERIOS 230 V	PRESTACIONES MÁXIMAS		PRESTACIONES (SET POINT REGULABLE)					
	P2 kW	HP		Q l/min	H metros	Set Point Min		Set Point Calibración Std		Set Point Max	
Monofásica						bar	l/min	bar	l/min	bar	l/min
TS2-MK 3/3	0.75	1	9.0 A	5 – 80	46 – 28	1.8	5 – 63	3.7	5 – 58	4.5	5 – 35
TS2-MK 3/4	1.1	1.5	9.0 A	5 – 80	62 – 38	2.4	5 – 62	4.9	5 – 58	6.1	5 – 33
TS2-MK 3/5	1.1	1.5	13.0 A	5 – 80	80 – 47	3.0	5 – 62	6.2	5 – 58	7.8	5 – 28
TS2-MK 3/6	1.5	2	13.0 A	5 – 80	96 – 56	3.6	5 – 63	7.4	5 – 58	9.4	5 – 25
TS2-MK 5/4	1.1	1.5	10.0 A	5 – 120	50 – 20	2.0	5 – 120	3.7	5 – 85	4.9	5 – 48
TS2-MK 5/5	1.1	1.5	12.0 A	5 – 120	63 – 25	2.5	5 – 120	4.6	5 – 85	6.2	5 – 48
TS2-MK 5/6	1.5	2	13.5 A	5 – 120	78 – 30	3.0	5 – 120	5.5	5 – 85	7.6	5 – 45
TS2-MK 5/7	1.8	2.5	16.0 A	5 – 120	92 – 34	3.5	5 – 118	6.5	5 – 85	9.0	5 – 43
TS2-MK 5/8	2.2	3	17.5 A	5 – 120	102 – 40	4.0	5 – 120	7.5	5 – 85	10.0	5 – 46
TS2-MK 8/4	1.5	2	14.0 A	5 – 180	50 – 15	2.0	5 – 167	3.7	5 – 120	4.9	5 – 70
TS2-MK 8/5	1.8	2.5	15.0 A	5 – 180	64 – 18	2.5	5 – 167	4.8	5 – 120	6.3	5 – 70
TS2-MK 8/6	2.2	3	16.0 A	5 – 180	80 – 20	3.1	5 – 163	5.5	5 – 120	7.8	5 – 53

# TISSEL-200 MK

CURVAS DE PRESTACIONES  $n=3450 \text{ min}^{-1}$

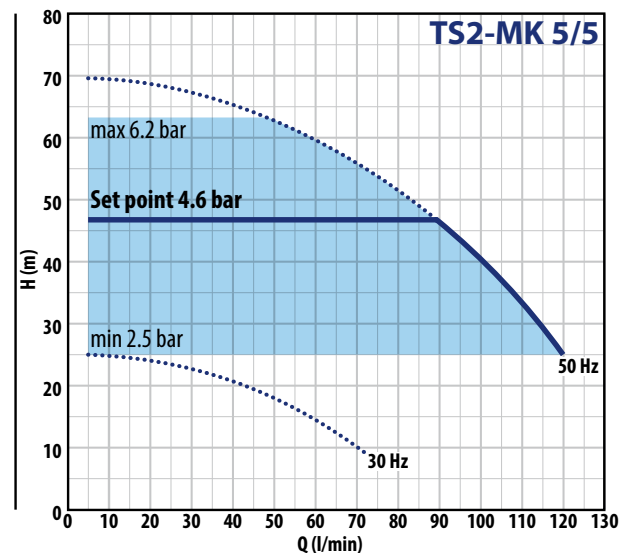
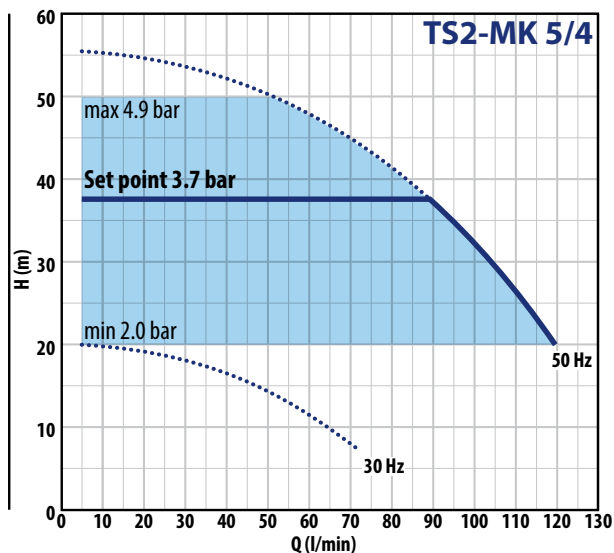
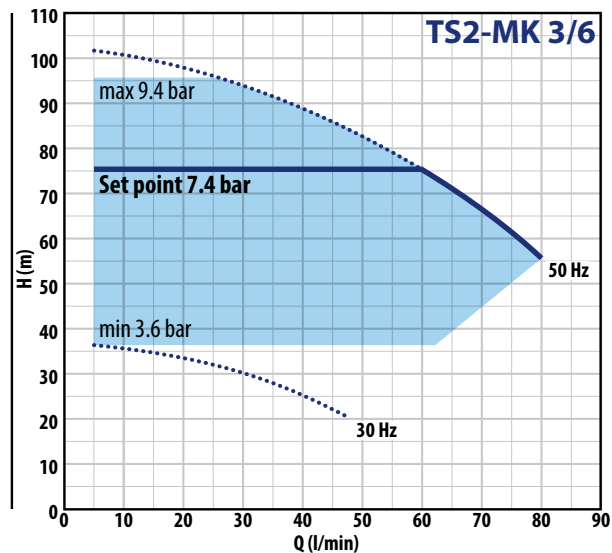
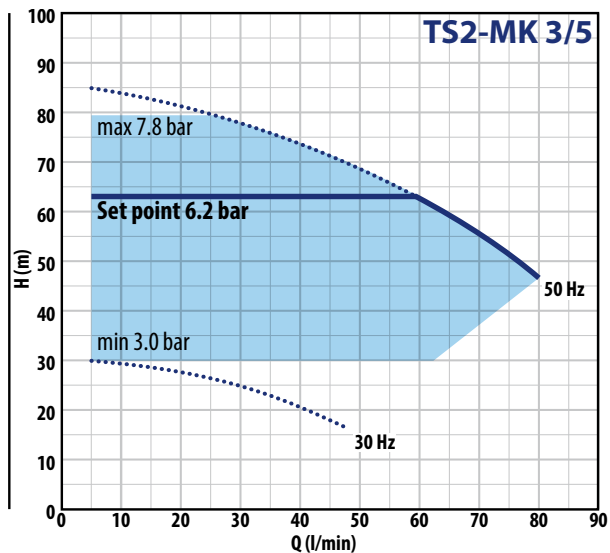
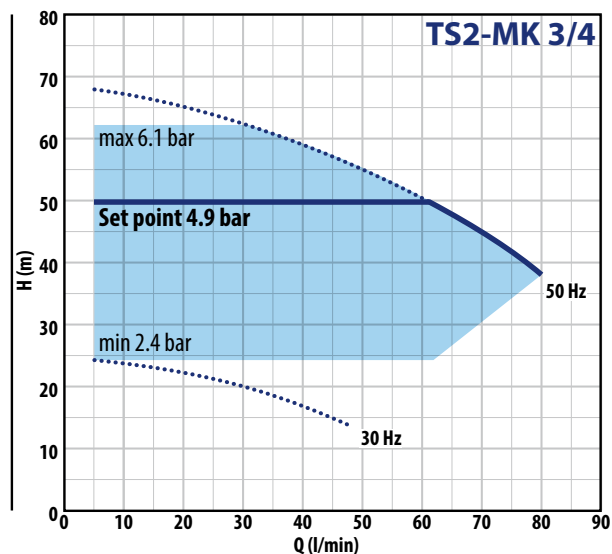
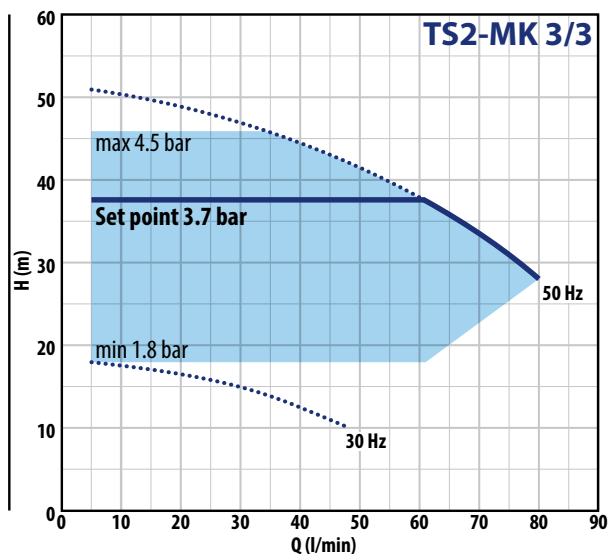

**CURVAS DE PRESTACIONES**  $n= 3450 \text{ min}^{-1}$

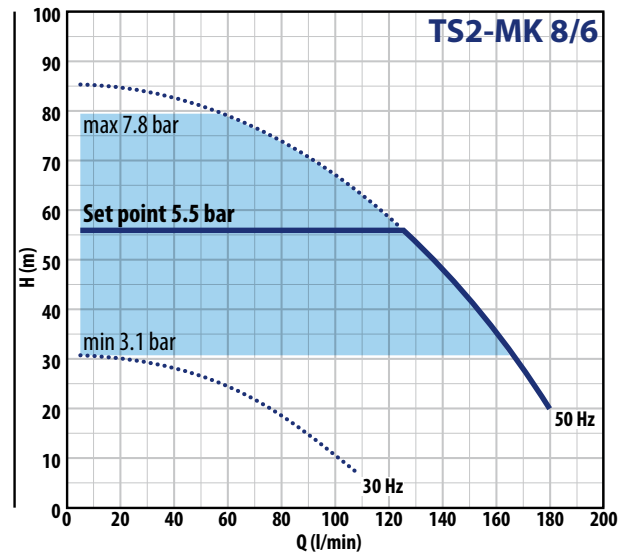
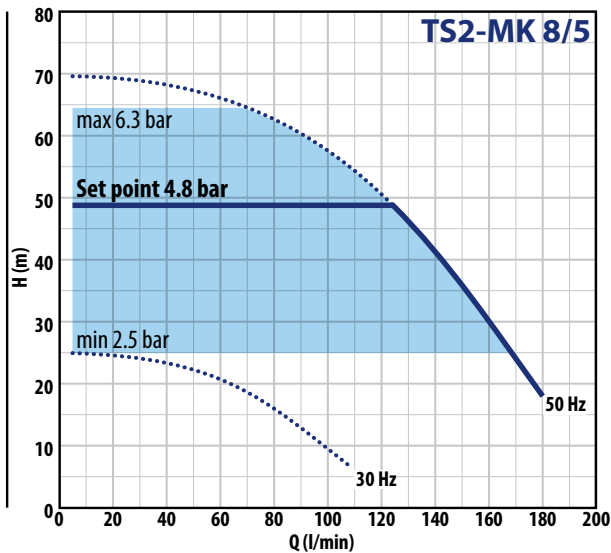
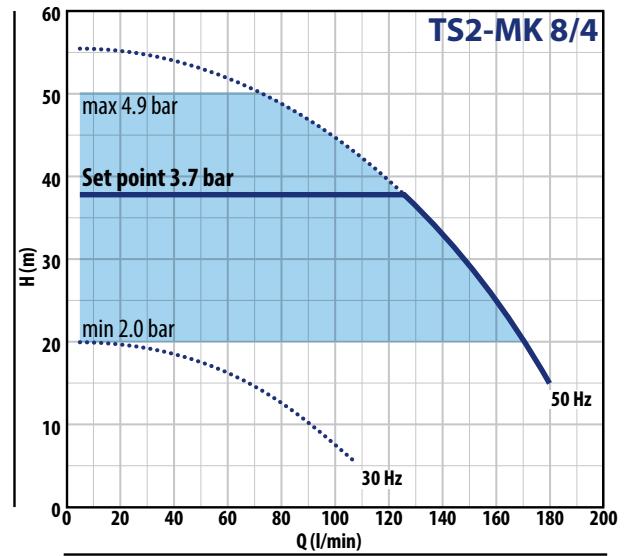
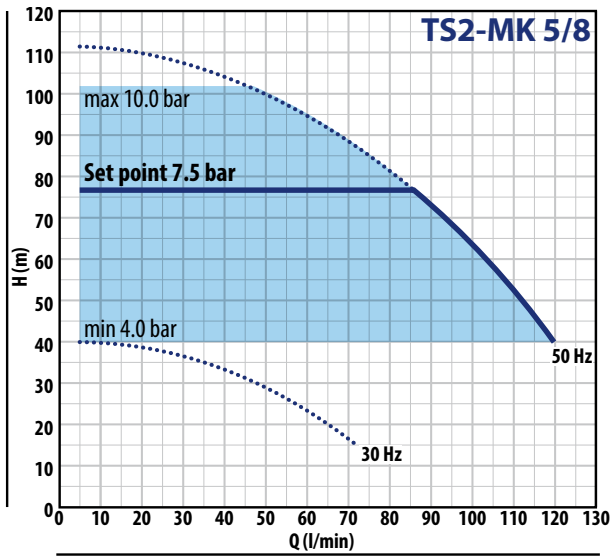
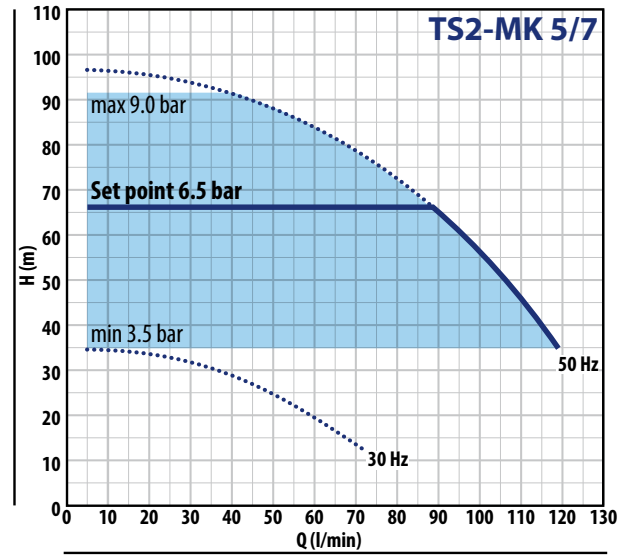
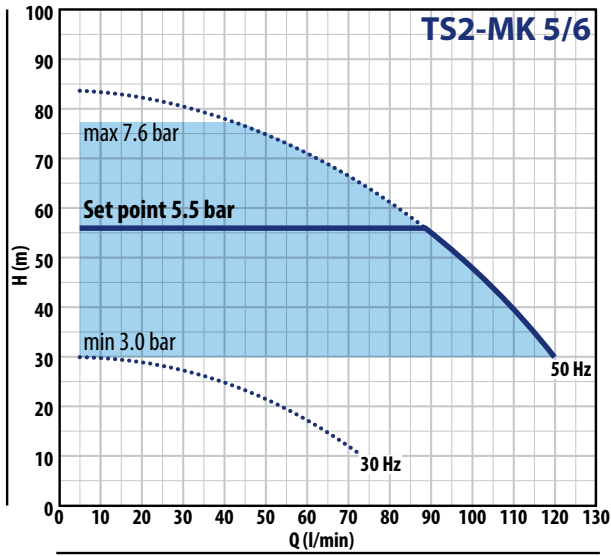

# TISSEL-200 FCR

CAMPO DE PRESTACIONES  $n = 3450 \text{ min}^{-1}$

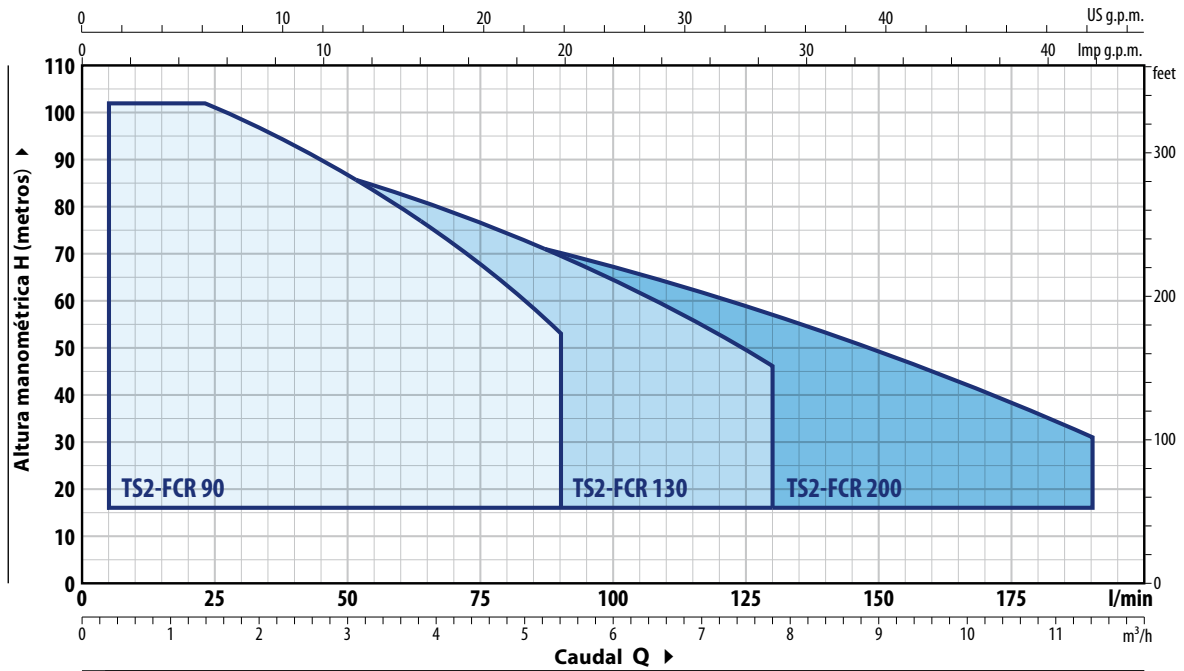

MODELO	POTENCIA		AMPERIOS	PRESTACIONES MÁXIMAS		PRESTACIONES (SET POINT REGULABLE)						
	P2			230 V	Q	H	Set Point Min		Set Point Calibración Std		Set Point Max	
Monofásica	kW	HP	▲	l/min	metros	bar	l/min	bar	l/min	bar	l/min	
TS2-FCR 90/5	1.1	1.5	IE3	13.0 A	5 – 90	78 – 38	2.80	5 – 75	5.30	5 – 65	7.10	5 – 23
TS2-FCR 90/6	1.5	2		13.5 A	5 – 90	94 – 45	3.40	5 – 75	6.30	5 – 65	8.60	5 – 21
TS2-FCR 90/7	1.8	2.5		16.0 A	5 – 90	110 – 53	4.00	5 – 75	7.50	5 – 65	10.00	5 – 21
TS2-FCR 130/3	1.1	1.5		12.5 A	5 – 130	49 – 24	1.80	5 – 110	3.40	5 – 92	4.30	5 – 48
TS2-FCR 130/4	1.5	2		14.5 A	5 – 130	65 – 31	2.30	5 – 110	4.40	5 – 92	5.80	5 – 45
TS2-FCR 130/5	1.8	2.5		18.5 A	5 – 130	81 – 39	2.90	5 – 110	5.50	5 – 92	7.40	5 – 38
TS2-FCR 130/6	2.2	3		20.5 A	5 – 130	97 – 45	3.50	5 – 110	6.50	5 – 92	9.00	5 – 33
TS2-FCR 200/3	1.1	1.5		10.0 A	5 – 200	43 – 13	1.60	5 – 185	2.80	5 – 133	3.80	5 – 72
TS2-FCR 200/4	1.5	2		13.0 A	5 – 200	57 – 17	2.10	5 – 185	3.60	5 – 133	5.10	5 – 65
TS2-FCR 200/5	1.8	2.5		16.0 A	5 – 200	72 – 22	2.60	5 – 185	4.60	5 – 133	6.50	5 – 56
TS2-FCR 200/6	2.2	3	22.0 A	5 – 200	86 – 26	3.10	5 – 185	5.50	5 – 133	7.90	5 – 45	

**CURVAS DE PRESTACIONES** n= 3450 min<sup>-1</sup>

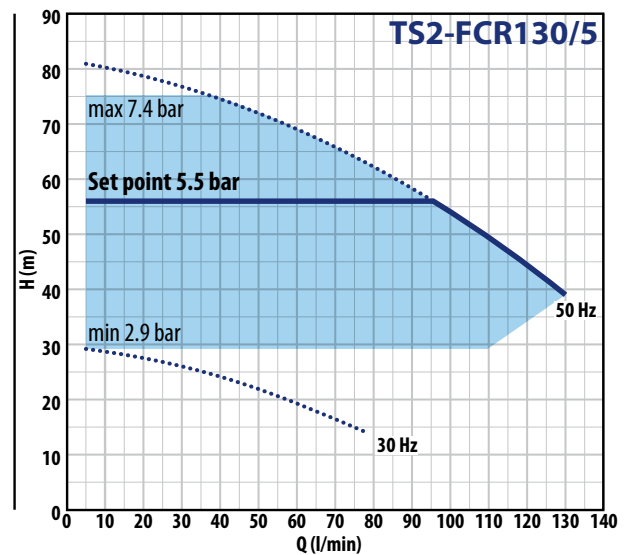
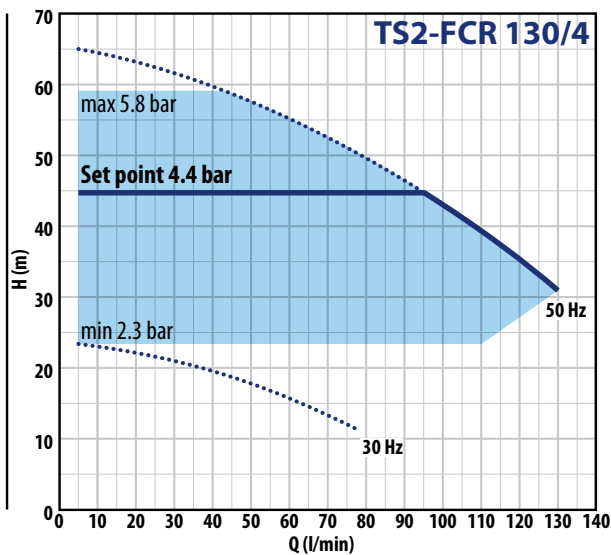
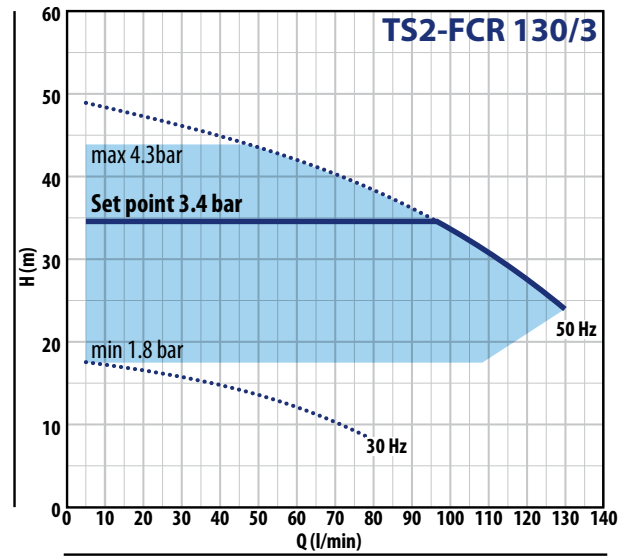
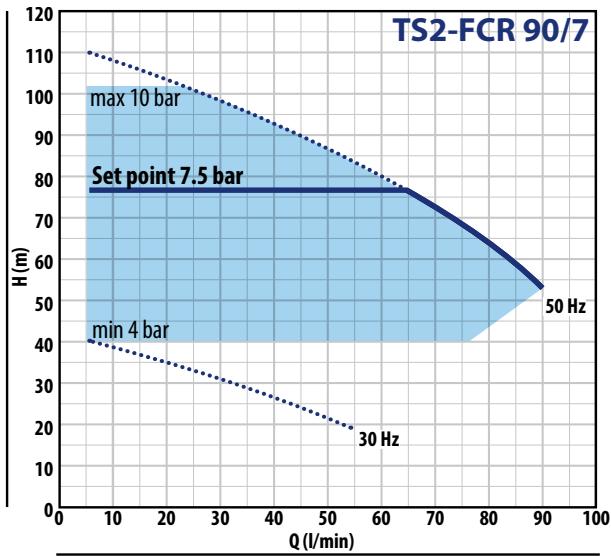
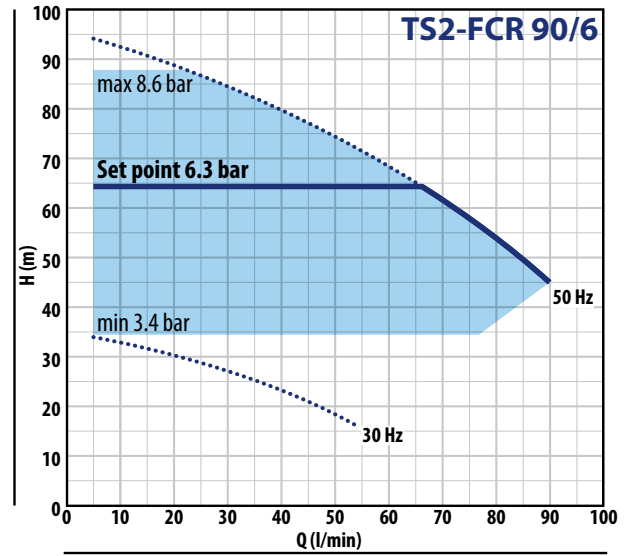
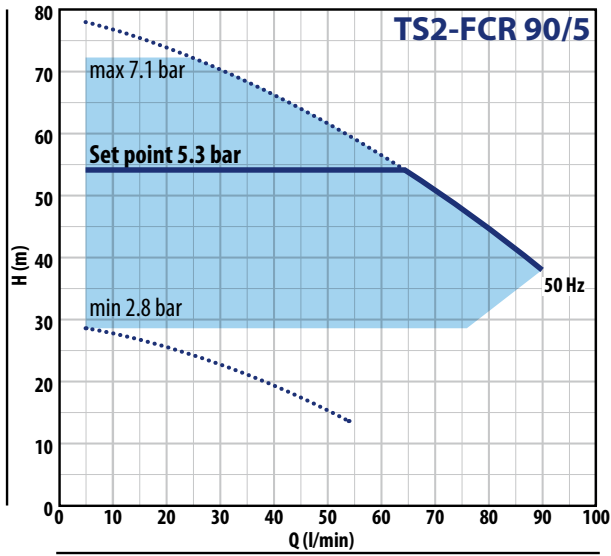

# TISSEL-200 FCR

CURVAS DE PRESTACIONES  $n=3450 \text{ min}^{-1}$

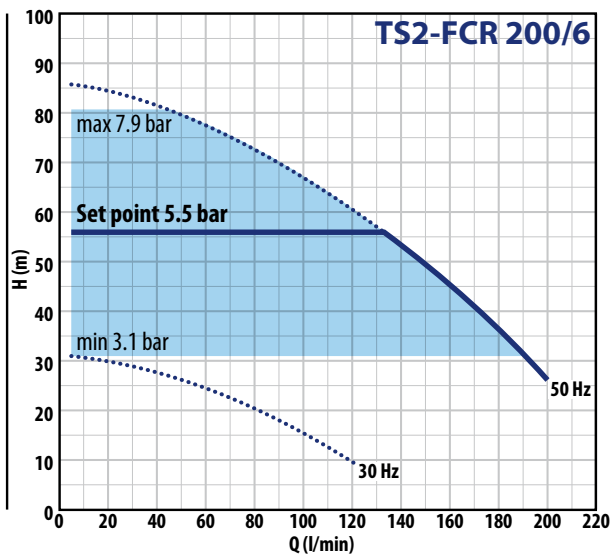
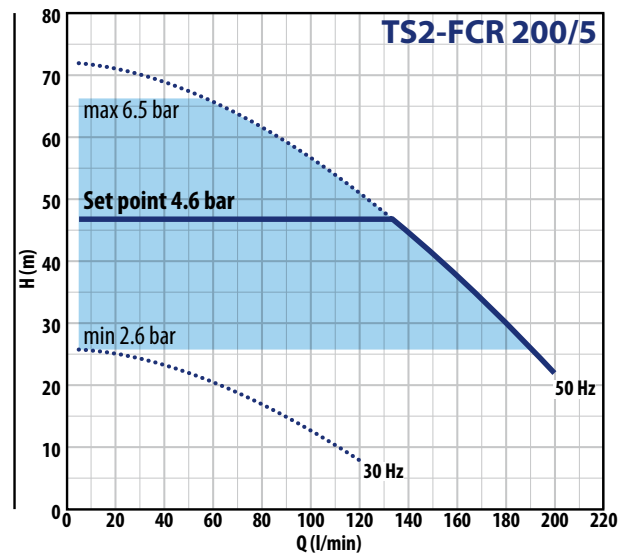
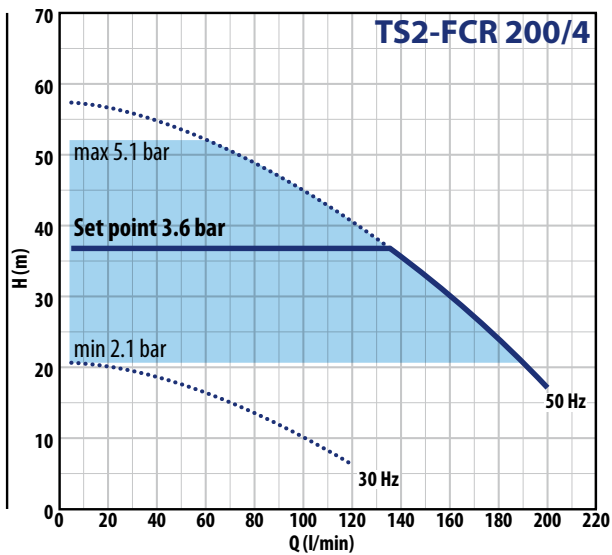
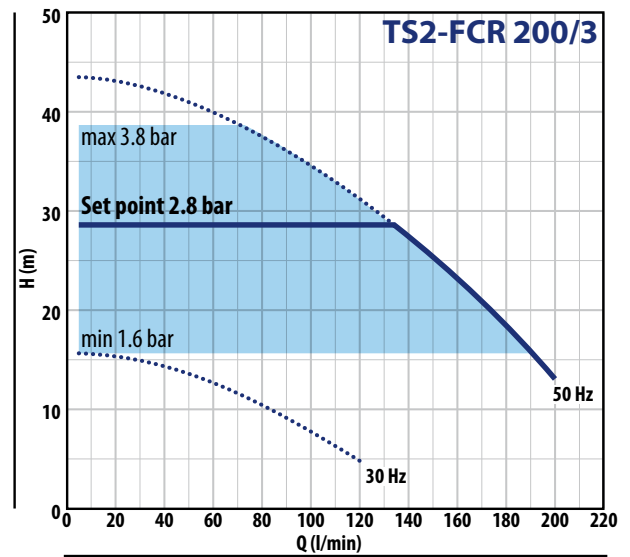
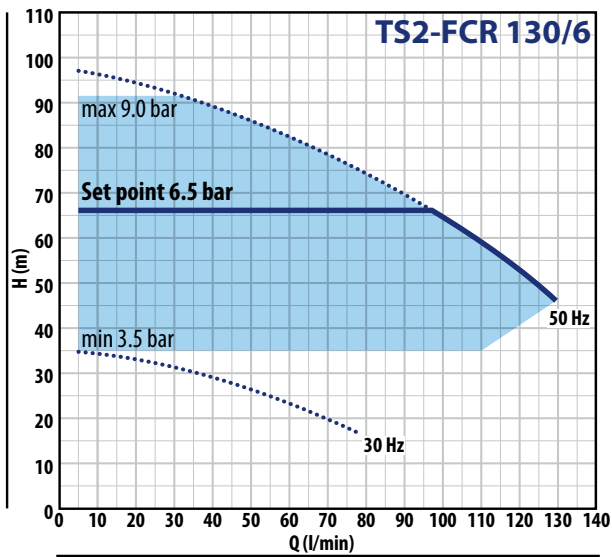



# TISSSEL-200 PLURIJET

## CAMPO DE PRESTACIONES n= 3450 min<sup>-1</sup>

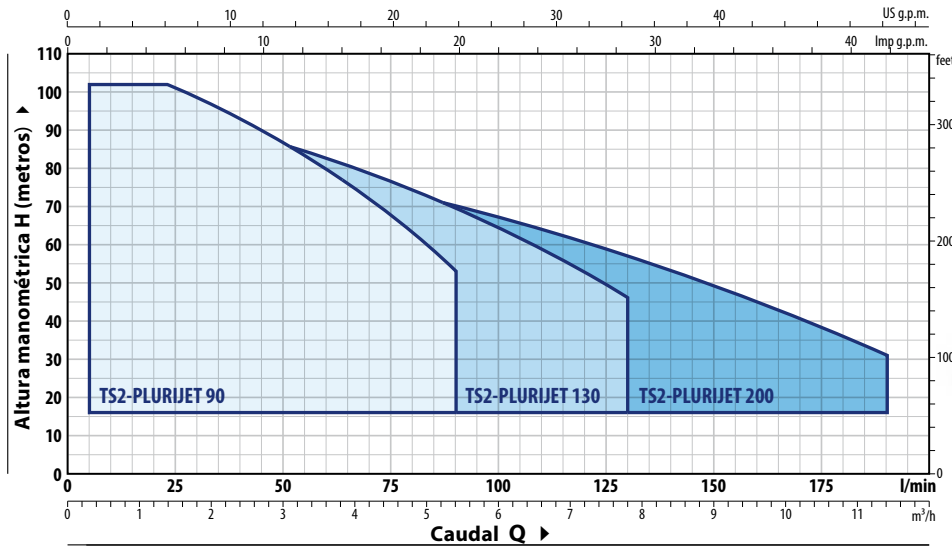

MODELO	POTENCIA		AMPERIOS	PRESTACIONES MÁXIMAS		PRESTACIONES (SET POINT REGULABLE)					
	P2 kW	HP		Q l/min	H metros	Set Point Min bar	Set Point Min l/min	Set Point Calibración Std		Set Point Max bar	Set Point Max l/min
Monofásica			230 V					bar	l/min	bar	l/min
TS2-PLURIJET 5/90	1.1	1.5	11.5 A	5 - 90	78 - 38	2.80	5 - 75	5.30	5 - 65	7.10	5 - 23
TS2-PLURIJET 6/90	1.5	2	13.5 A	5 - 90	94 - 45	3.40	5 - 75	6.30	5 - 65	8.60	5 - 21
TS2-PLURIJET 3/130	1.1	1.5	12.5 A	5 - 130	49 - 24	1.80	5 - 110	3.40	5 - 92	4.30	5 - 48
TS2-PLURIJET 4/130	1.5	2	14.5 A	5 - 130	65 - 31	2.30	5 - 110	4.40	5 - 92	5.80	5 - 45
TS2-PLURIJET 5/130	1.8	2.5	18.5 A	5 - 130	81 - 39	2.90	5 - 110	5.50	5 - 92	7.40	5 - 38
TS2-PLURIJET 6/130	2.2	3	20.0 A	5 - 130	97 - 45	3.50	5 - 110	6.50	5 - 92	9.00	5 - 33
TS2-PLURIJET 3/200	1.1	1.5	10.0 A	5 - 200	43 - 13	1.60	5 - 185	2.80	5 - 133	3.80	5 - 72
TS2-PLURIJET 4/200	1.5	2	16.0 A	5 - 200	57 - 17	2.10	5 - 185	3.60	5 - 133	5.10	5 - 65
TS2-PLURIJET 5/200	1.8	2.5	16.0 A	5 - 200	72 - 22	2.60	5 - 185	4.60	5 - 133	6.50	5 - 56
TS2-PLURIJET 6/200	2.2	3	22.0 A	5 - 200	86 - 26	3.10	5 - 185	5.50	5 - 133	7.90	5 - 45

## CURVAS DE PRESTACIONES n= 3450 min<sup>-1</sup>

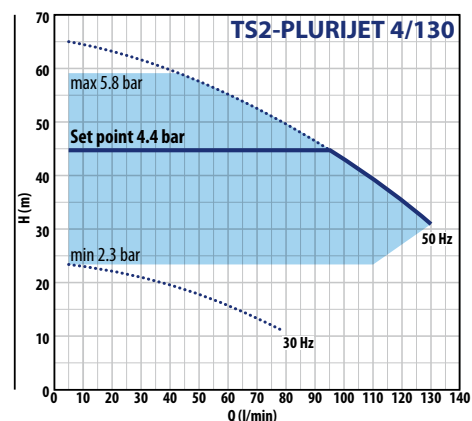
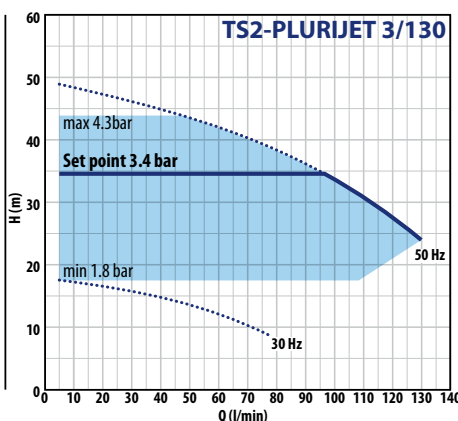
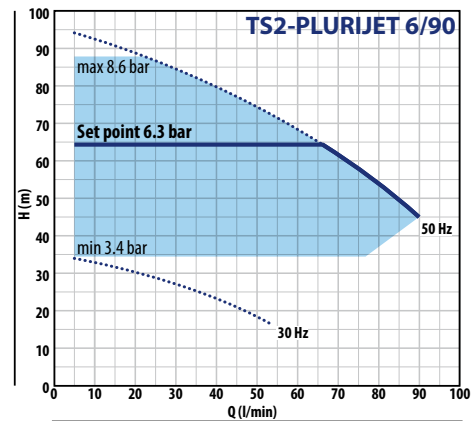
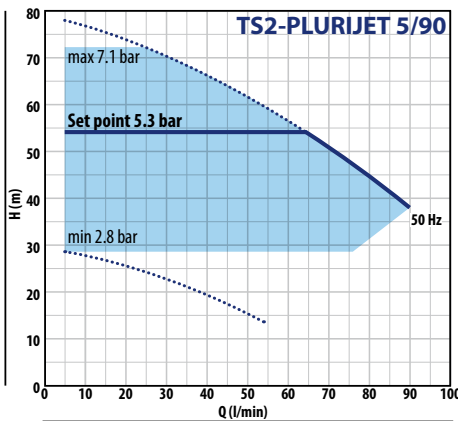



# TISSEL-200 PLURIJET

CURVAS DE PRESTACIONES  $n=3450 \text{ min}^{-1}$

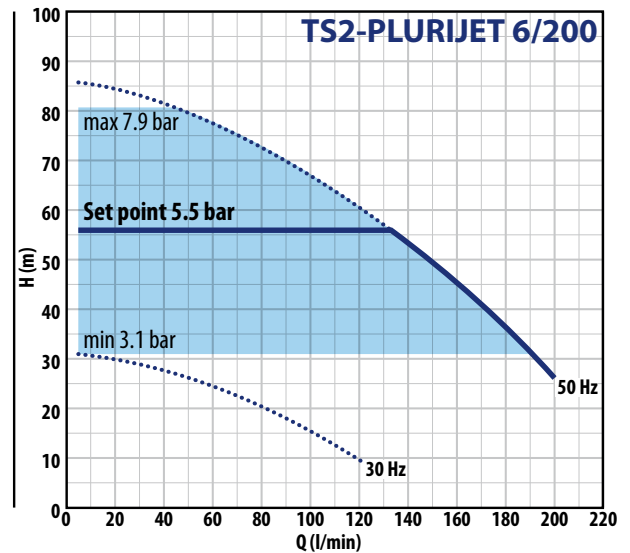
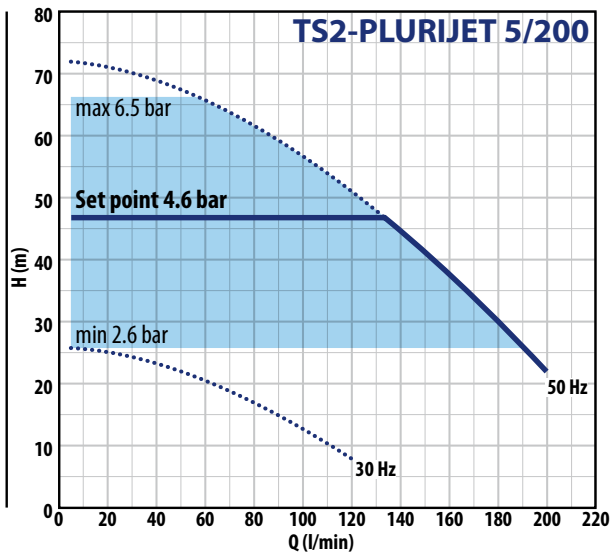
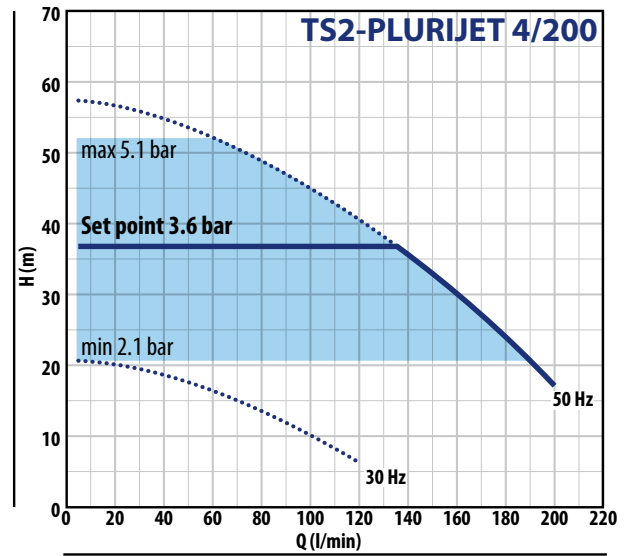
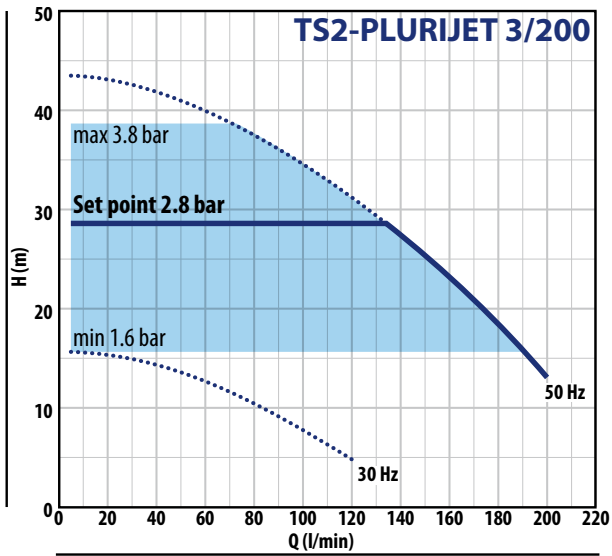
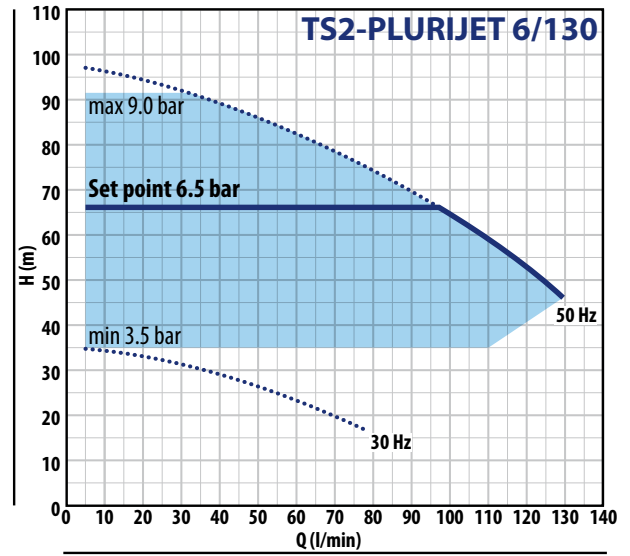
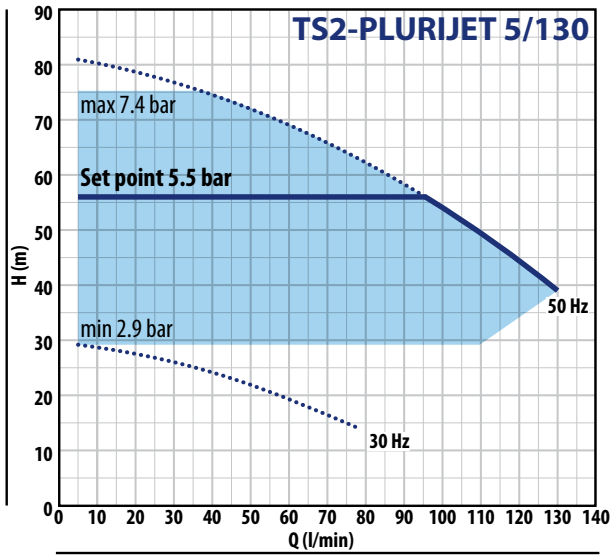

## DIMENSIONES (mm)

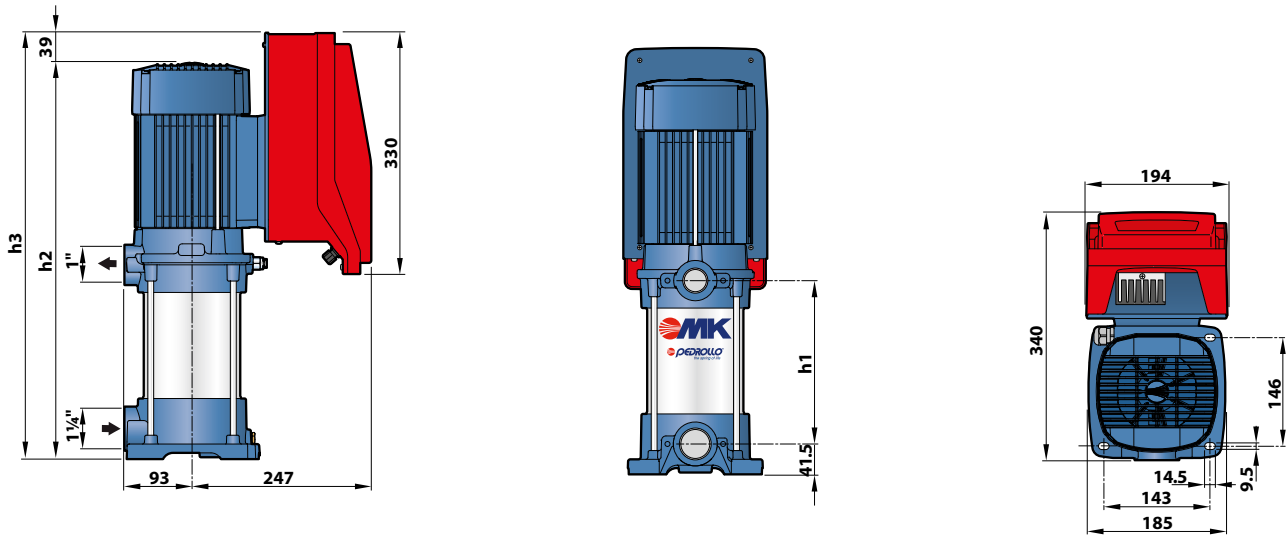

MODELO	h1	h2	h3	kg
TS2-MK 3/3	132.5	450	489	26.7
TS2-MK 3/4	159.5	477	516	27.0
TS2-MK 3/5	186.5	504	543	28.6
TS2-MK 3/6	213.5	531	570	30.1
TS2-MK 5/4	159.5	477	516	26.9
TS2-MK 5/5	186.5	504	543	28.5
TS2-MK 5/6	213.5	531	570	30.3
TS2-MK 5/7	240.5	558	597	30.7
TS2-MK 5/8	267.5	585	624	30.9
TS2-MK 8/4	159.5	477	516	28.0
TS2-MK 8/5	186.5	504	543	29.6
TS2-MK 8/6	213.5	531	570	30.4

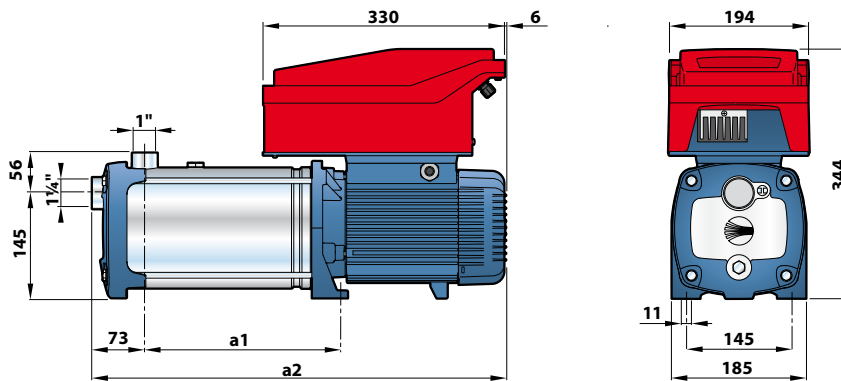

MODELO	a1	a2	kg
TS2-FCR 90/5	193	497	26.3
TS2-FCR 90/6	219	523	28.4
TS2-FCR 90/7	245	569	32.5
TS2-FCR 130/3	141	445	25.0
TS2-FCR 130/4	167	471	26.9
TS2-FCR 130/5	193	517	30.3
TS2-FCR 130/6	219	543	31.2
TS2-FCR 200/3	141	445	25.0
TS2-FCR 200/4	167	471	26.9
TS2-FCR 200/5	193	517	30.3
TS2-FCR 200/6	219	543	31.2

MODELO	a1	a2	kg
TS2-PLURIJET 5/90	245	549	27.0
TS2-PLURIJET 6/90	271	575	29.0
TS2-PLURIJET 3/130	193	497	25.1
TS2-PLURIJET 4/130	219	523	27.1
TS2-PLURIJET 5/130	245	569	30.7
TS2-PLURIJET 6/130	271	595	31.8
TS2-PLURIJET 3/200	193	497	25.1
TS2-PLURIJET 4/200	219	523	27.1
TS2-PLURIJET 5/200	245	569	30.7
TS2-PLURIJET 6/200	271	595	31.8